

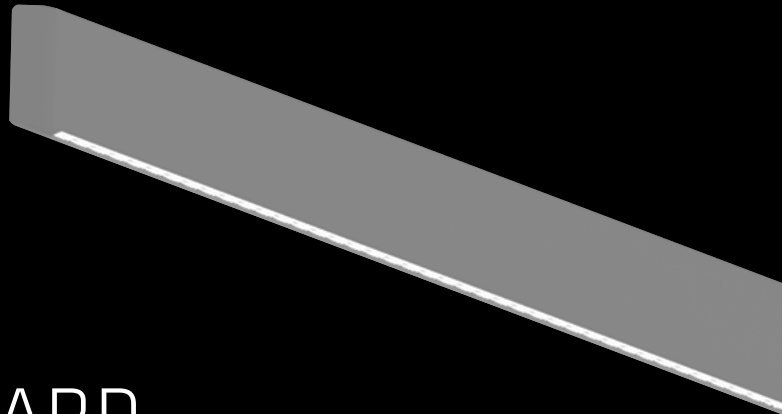

LINES 



FORWARD





AT EVER

RY TURN

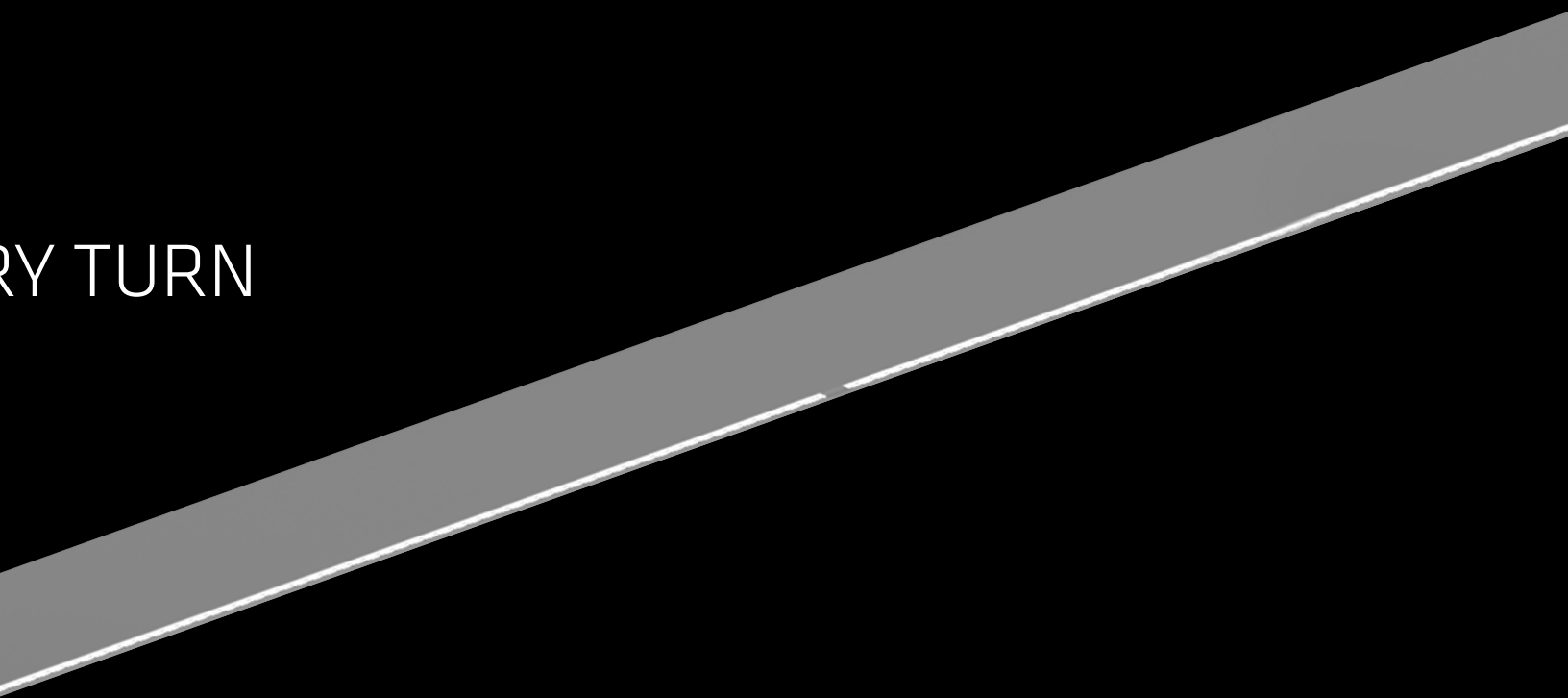

# LINES

Connect. Create. Deviate.

A divergent and diminutive  
suspended system for the inspired.

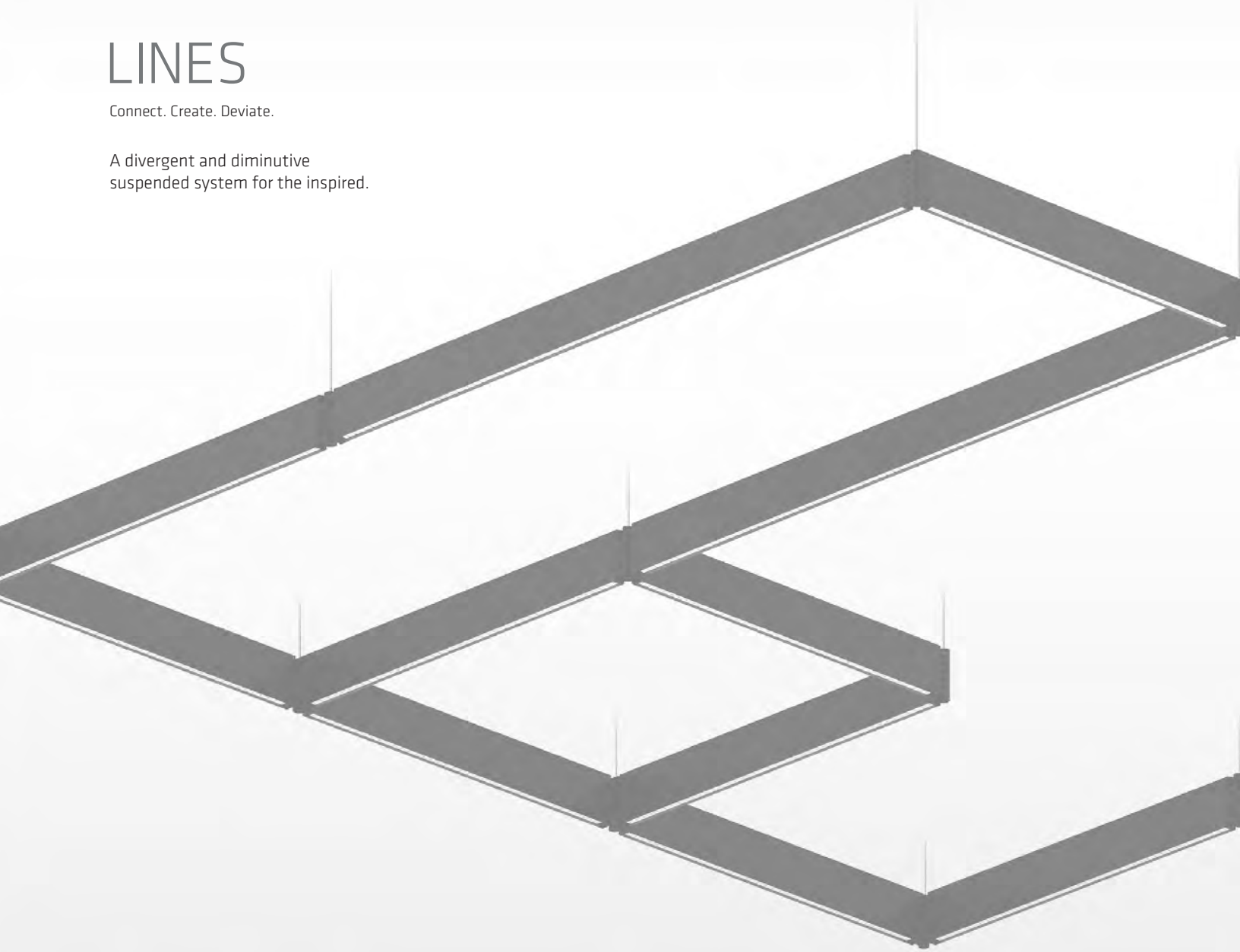

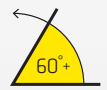
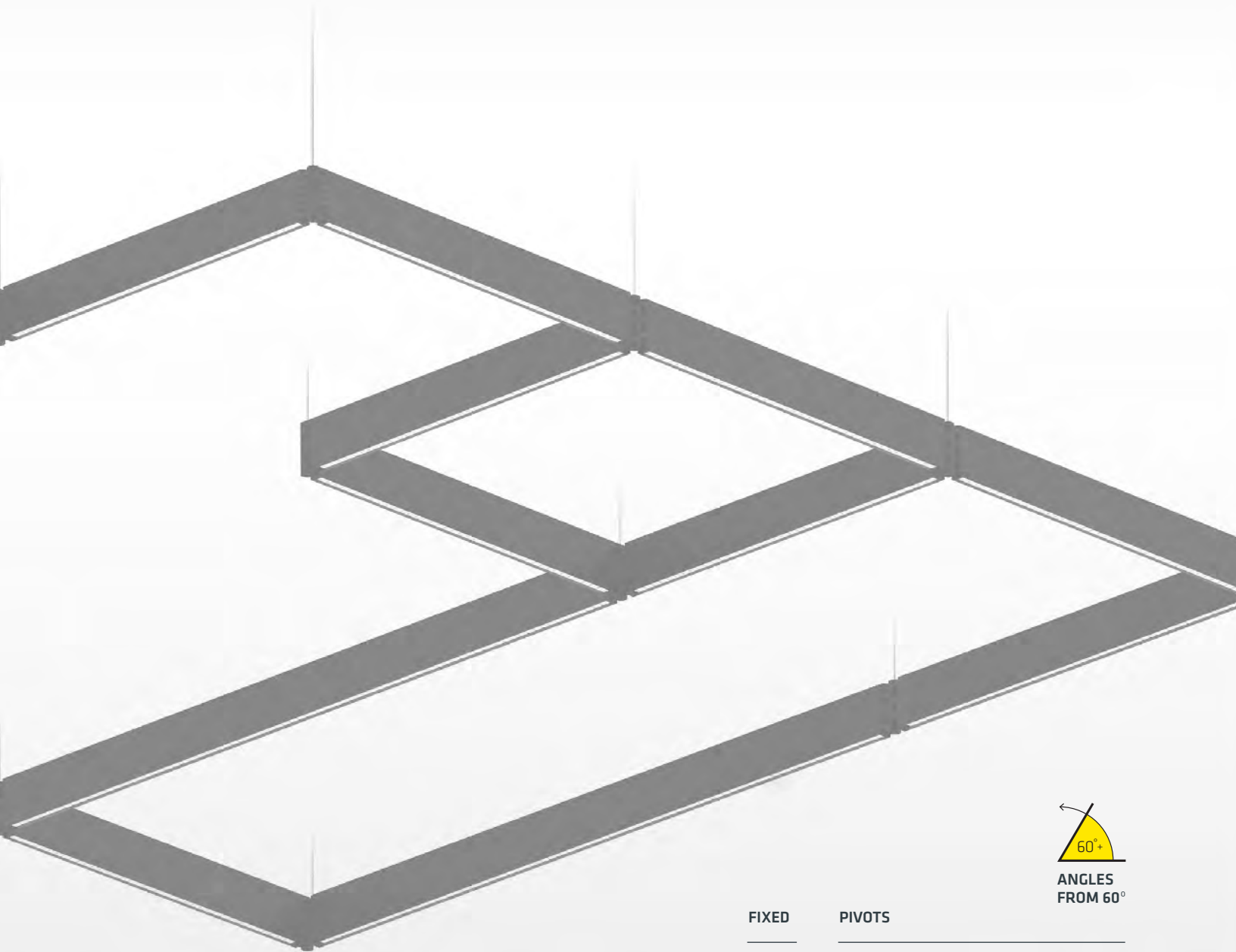

ANGLES FROM 60°

FIXED

PIVOTS

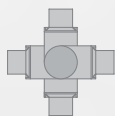
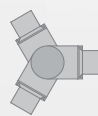

2-WAY

2-WAY

3-WAY

4-WAY

# MINIMALISM MEETS MINISCULE

Clean, modern and miniature, Lines mimics the height and width of the Portal pendant, and shares the same narrow-gauge integrated power and suspension cord. The three distributions, multiple pivoting luminaire and wall connections, three distinct endcaps, and three powdercoat finishes give way to immeasurable design potential.





DIMENSIONS

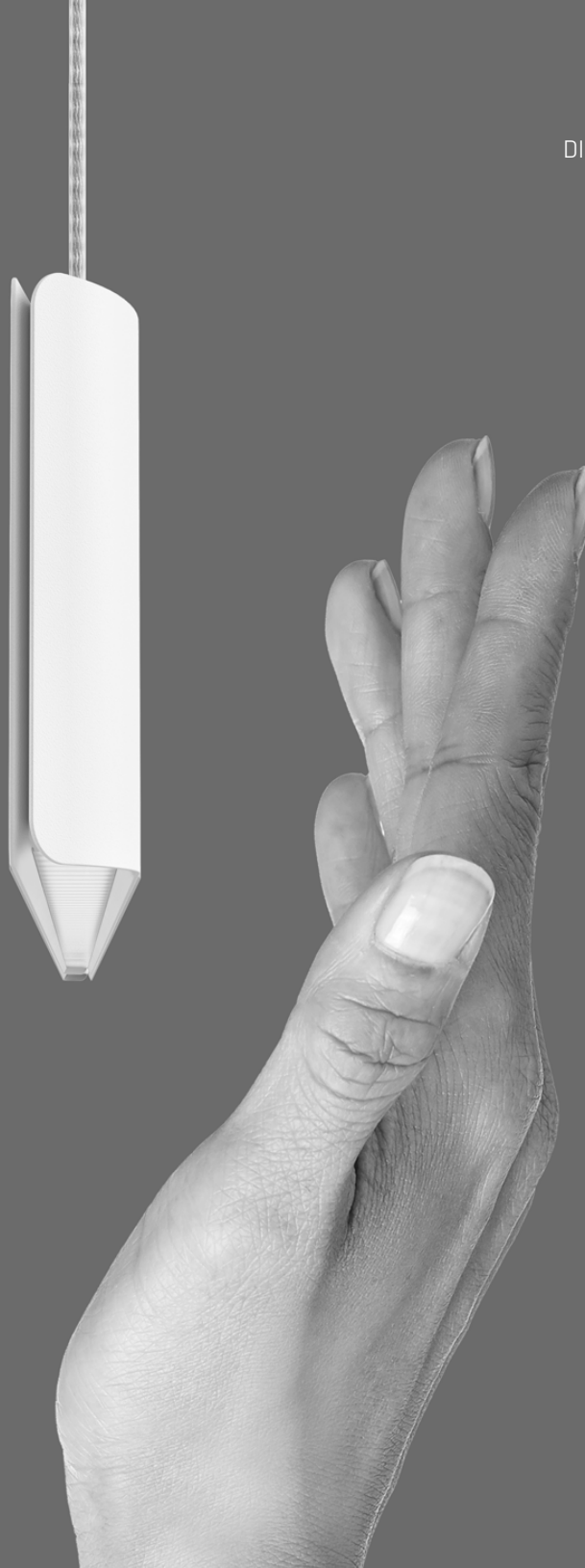

SCALE 1:1

# ENDCAPS



SAIL



CAPSULE



FLAT

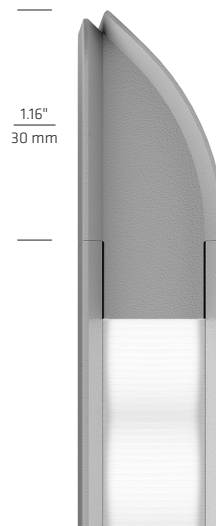

1.16"  
30 mm

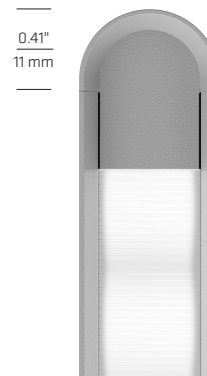

0.41"  
11 mm

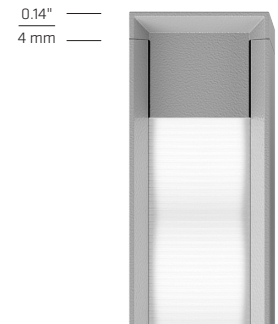

0.14"  
4 mm

SCALE 1:1







Reference



## NOT A LINE, A LINEAGE

From the beginning, Fluxwerx transformed linear suspended luminaire design and performance, giving it a new lineage. Configurable into endless shapes and patterns, Lines lets you tell your own story. Use it as part of a ceiling or longer runs with spacing up to 10 ft o.c. An optimal balance of diminutive design and performance.



g designers new ways to realize their vision.  
complex layout, or as a discrete element in short  
without compromise. Lines fits, everywhere.









PIVOTS

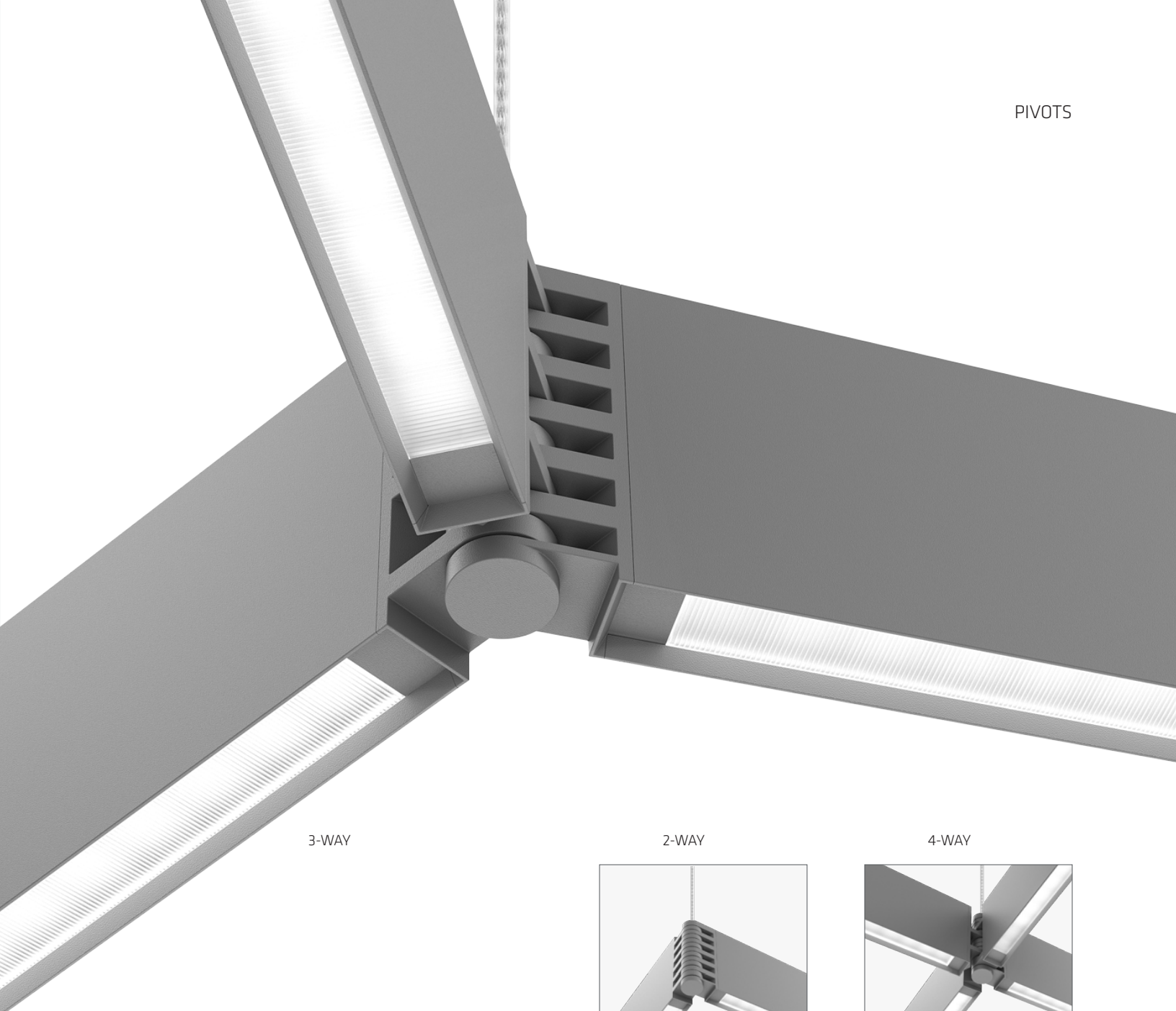

3-WAY

2-WAY

4-WAY

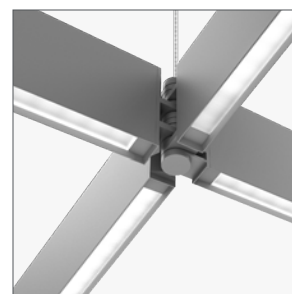
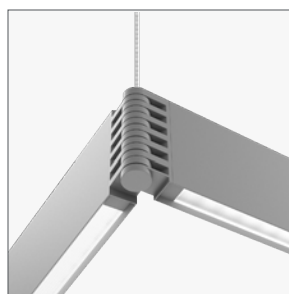











3-WAY



WALL MOUNTS

2-WAY

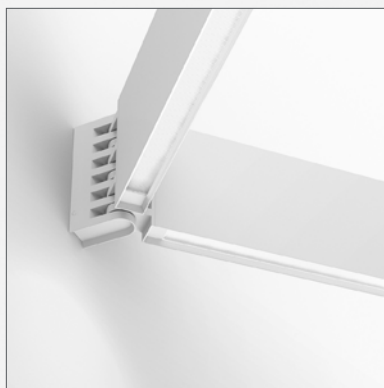

WALL PIVOT

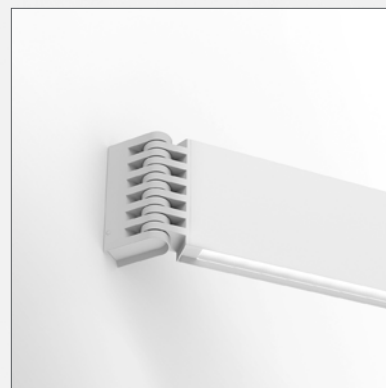



WALL MOUNTS



# PRECISION COMFORT CONTROL

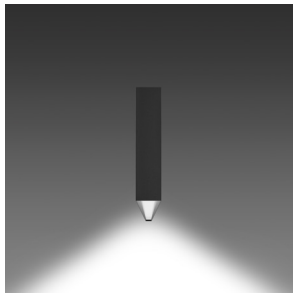

100 Dn

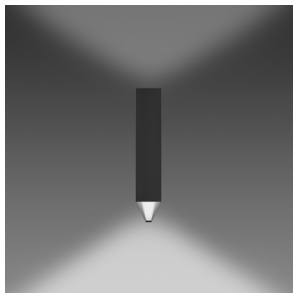

35 Up | 65 Dn

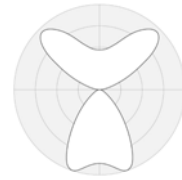
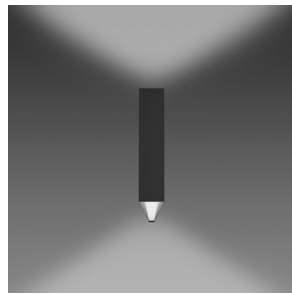

60 Up | 40 Dn

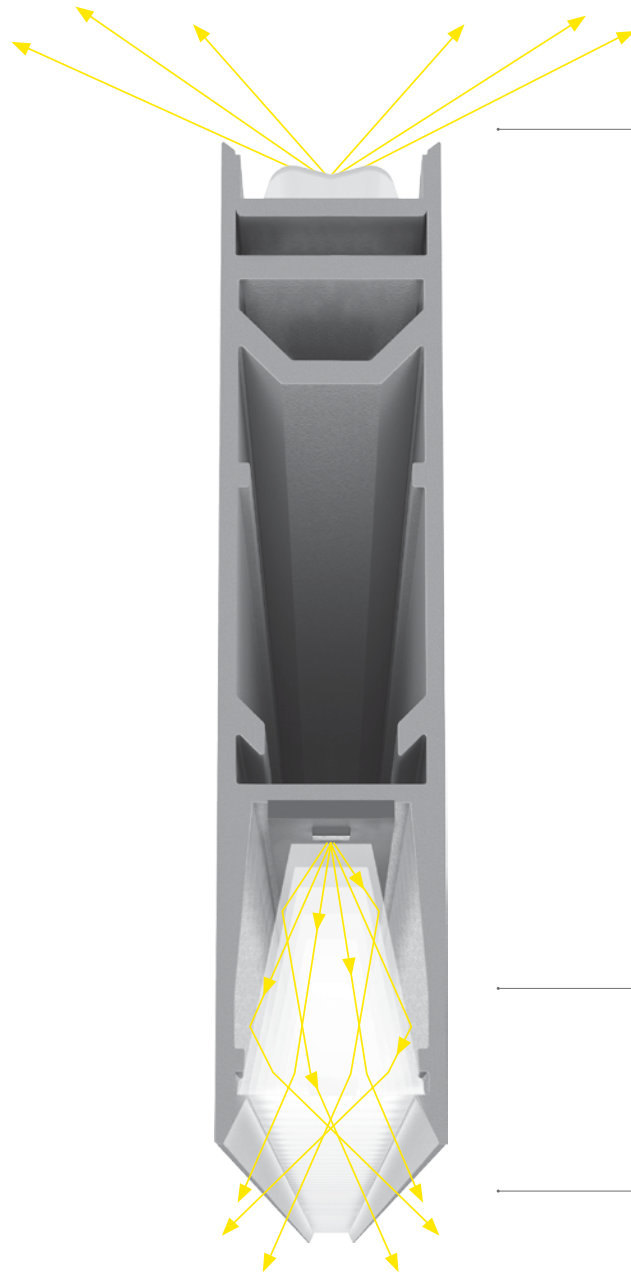

Direct and indirect optics address a broad range of applications with exceptional uniformity and lower energy densities.

Proprietary optics internally refract, reflect and mix light to transform individual bright point sources into a homogenized spread of light with accurate and consistent color.

Precise control and extraction features shape the light into high performance distributions with maximum visual comfort and efficacies exceeding 140 lm/w.







Black Fixture  
Black Cable



POWDERCOAT FINISHES

Silver Fixture  
Silver Cable

White Fixture  
Silver Cable

  
RAL options  
available

1.ZERO









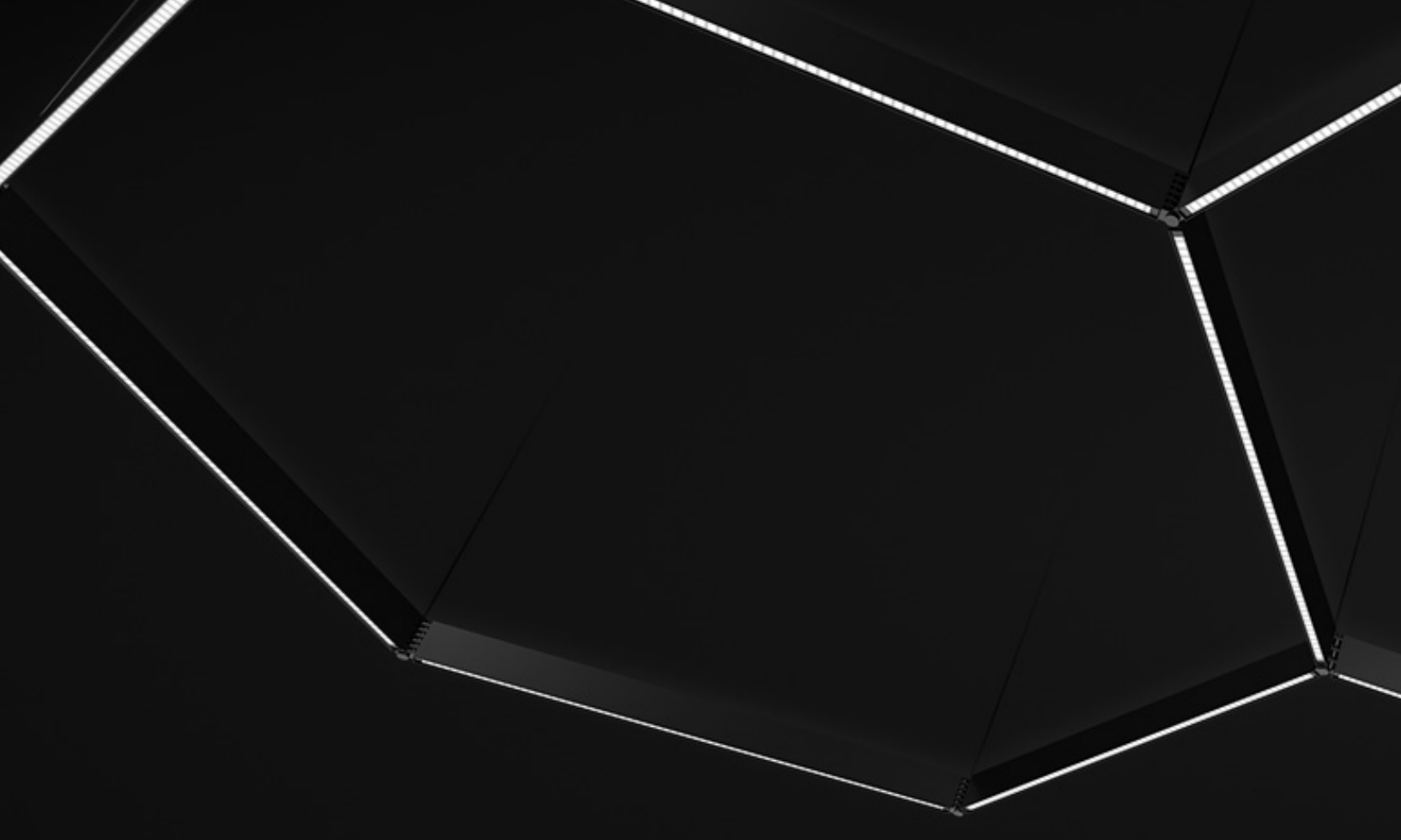

# INSPIRATION INTERSECTS

Lines. A collection of elements that connects with your creativity. Form a discrete expression in joinable sections of 2, 3, 4, 6 or 8 ft with multi-way pivoting intersections and wall mounts. Get started with available predefined shapes, or create your own custom design.

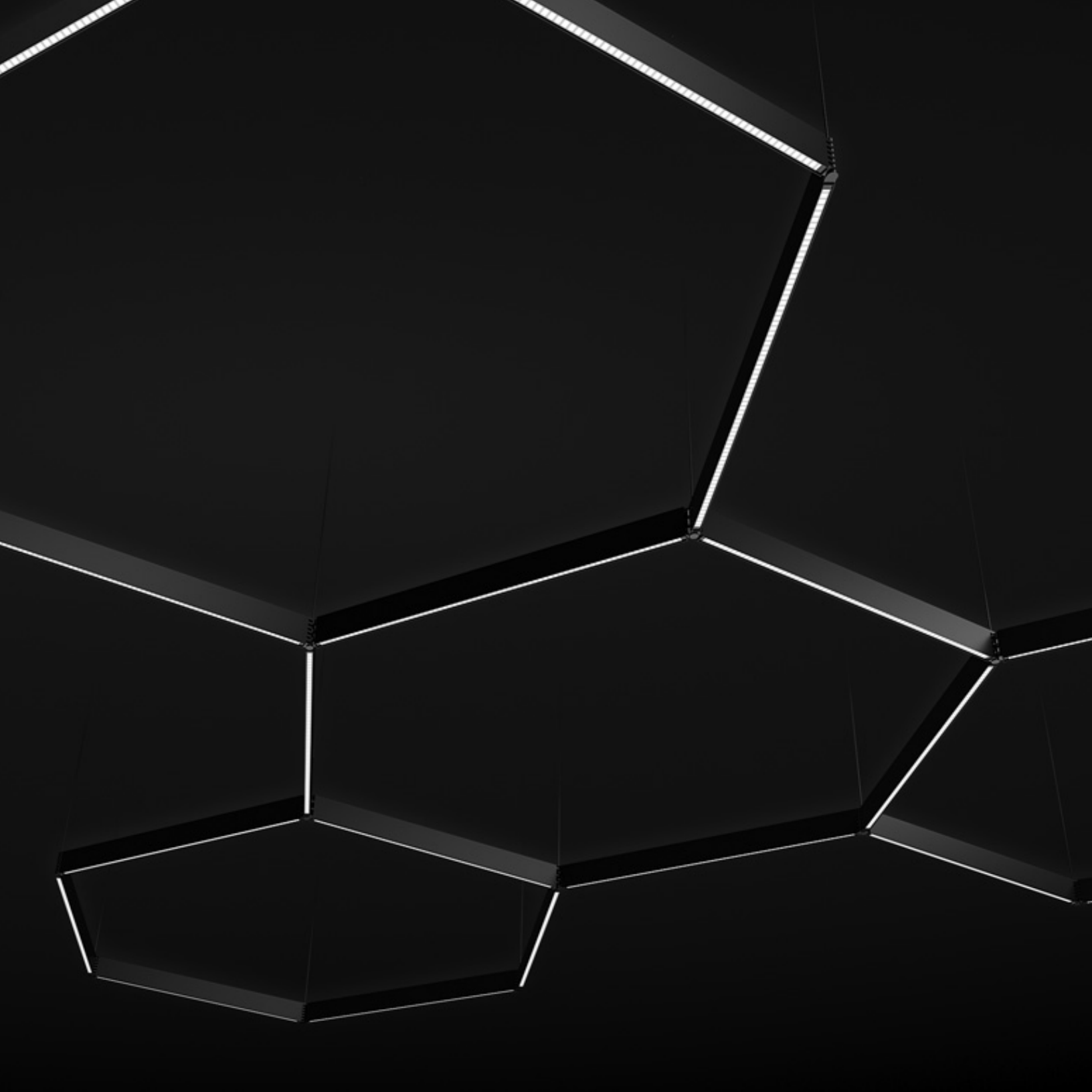

# SHAPES

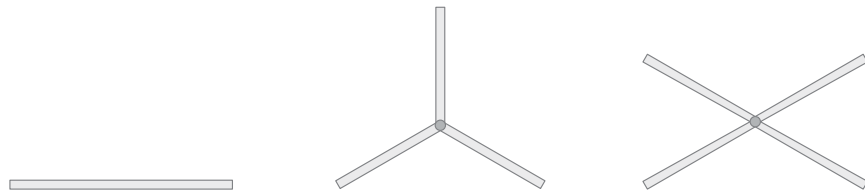

**LINES + BRANCHES**

Straight Lines

3-Spoke

4-Spoke

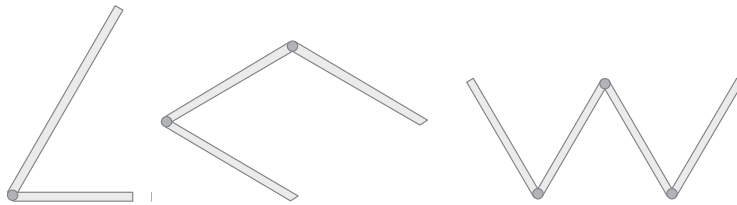

**OPEN SHAPES**

2 Lines + 2-Way Pivot

3 Lines + 2-Way Pivots

Lines + 2-Way Pivots

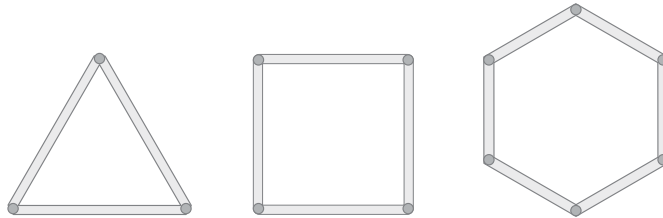

**CLOSED SHAPES**

Triangle

Square

Lines + 2-Way Pivots







GEOMETRY

# YOUR SHAPES

From simple to complex, Lines lets you plan and design as you have, and have never before.

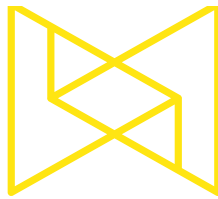





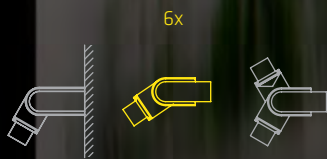

6x



4x



9x

PIVOTS

CANOPY MOUNT

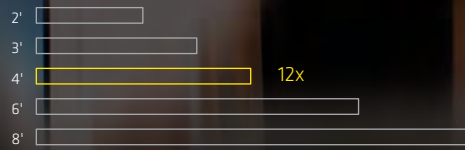

12x

LENGTHS

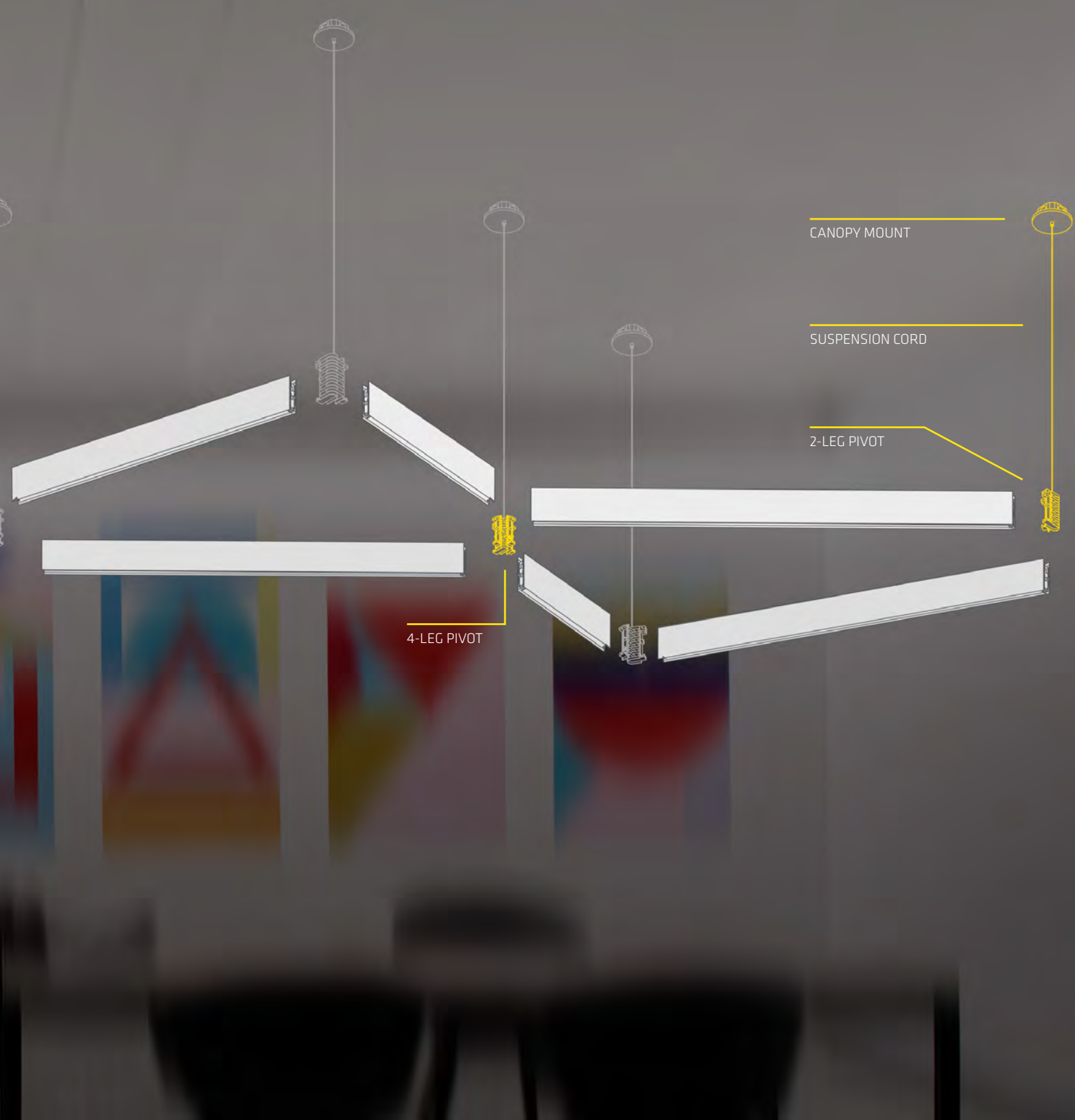

CANOPY MOUNT

SUSPENSION CORD

2-LEG PIVOT

4-LEG PIVOT





## APPLICATIONS

ENVIRONMENT	SPACE (L' x W' x H')	SHAPE	DISTRIBUTION	ENERGY (W/4ft)	QTY	DROP	SPACING	UNIFORMITY		LIGHT (fc)	W/FT <sup>2</sup>
								DESK	CEILING (MAX   MIN)		
Open Office	60 x 60 x 9	Straight Row	60 Up   40 Dn	12	8	18"	8' o.c.	1.6	2.1	40	0.36
Open Office	60 x 60 x 9	6' Individual	35 Up   65 Dn	12	70	18"	8' x 6'	1.4	1.6	41	0.35
Open Ceiling	60 x 60 x 12	12' x 8' Rectangle	35 Up   65 Dn	12	12	36"	20' x 15'	1.9	2.0	44	0.40
High Ceiling	60 x 60 x 15	8' Square	100 Dn	9.5	16	60"	15' o.c.	1.9	N/A	39	0.34
Meeting Room	18 x 12 x 9	4' Individual	35 Up   65 Dn	18	4	18"	8' x 6'	1.9	3.9	35	0.34
Private Office	12 x 9 x 9	6' Individual	60 Up   40 Dn	18	2	24"	6' o.c.	1.6	2.2	38	0.49
Teaching Space	32 x 30 x 9	8' Individual	100 Dn	12	15	18"	10' x 6'	1.7	N/A	45	0.37
Public Area	40 x 30 x 12	2' Square	35 Up   65 Dn	12	20	36"	8' o.c.	1.5	1.5	38	0.40



## LENGTHS

All fixtures are factory pre-wired. Joints, endcaps and pivots are factory preinstalled up to a maximum shippable length of 8 ft. Section lengths can be joined together to create any row length beginning at 2' and continuing in 1' increments.



## ORDER GUIDE

### GENERAL FEATURES

FAMILY	CONFIGURATION	LAYOUT	CEILING	SUSPENSION	FINISH	DIST	
<b>LN1</b> Lines	<b>P</b> Predefined Shape	<b>#</b> Number of Sides <b>Y</b> 3-Spoke <b>X</b> 4-Spoke	<b>D</b> Drywall <b>G</b> Grid <b>S</b> Structure <b>R</b> Remote	<b>03</b> ≤3 ft <b>06</b> ≤6 ft <b>12</b> ≤12 ft <b>25</b> ≤25 ft	<b>FIXTURE</b> <b>B</b> Black Powdercoat <b>K</b> Black Powdercoat, Black Cord   Coupler <b>S</b> Metallic Silver Powdercoat <b>W</b> White Powdercoat <b>C</b> Custom Color (RAL)	<b>CANOPY</b> <b>B</b> <b>K</b> <b>S</b> <b>W</b> <b>C</b>	<b>W1</b> <b>W3</b> <b>W6</b>
CRI	CCT	ENERGY	DRIVER	VOLTAGE	OPTIONS		
<b>8</b> 80 CRI <b>9</b> 90 CRI	<b>30</b> 3000 K <b>35</b> 3500 K <b>40</b> 4000 K	<b>A</b> 9.5 W <b>B</b> 12 W <b>C</b> 15 W <b>D</b> 18 W <b>E</b> 22 W <b>F</b> 27 W	<b>F1</b> Non-Dim <b>F2</b> 0-10V Dim 3% <b>E1</b> eldoLED ECO 0-10V Dim 1% <b>E2</b> eldoLED SOLO 0-10V Dim 0.1% <b>E3</b> eldoLED ECO DALI 1% <b>E4</b> eldoLED SOLO DALI Dim 0.1% <b>L1</b> Lutron Hi-Lume 1% EcoSystem <b>L2</b> Lutron Hi-Lume 1% 2-Wire 120V <b>L3</b> Lutron HL Premier 0.1% EcoSystem	<b>M</b> 120-277 V <b>1</b> 120 V <b>2</b> 277 V <b>3</b> 347 V	<b>B#</b> Battery Pack Qty <b>H#</b> Emergency Switch Qty <b>C</b> Chicago Plenum <b>G</b> 6 ft Modules		

### SHAPE GEOMETRY

START	SIDE LENGTH 1	OPTIONAL SIDE LENGTH 2	OPTIONAL SIDE LENGTH 3	OPTIONAL END
<b>ENDS</b> <b>A</b> Sail Endcap <b>F</b> Flat Endcap <b>P</b> Capsule Endcap <b>W</b> Wall Pivot	<b>##</b> 1st Side Length in Ft	<b>##</b> 2nd Side Length in Ft	<b>##</b> 3rd Side Length in Ft	<b>OPEN SHAPE</b> See START options
<b>PIVOTS</b> <b>V</b> 2-Way Pivot <b>Y</b> 3-Way Pivot <b>X</b> 4-Way Pivot <b>K</b> Wall 2-Way Pivot <b>M</b> Wall 3-Way Pivot				<b>CLOSED SHAPE</b> <b>N</b> None

See specification document for details. Separate Order Guide for more complex patterns - see specification document. Please provide a layout sketch or drawing.

**DISTRIBUTION**

100 Dn

35 Up | 65 Dn

60 Up | 40 Dn







## CONTROLS + SENSORS

Our flexible integrated mounting options provide easy installation for any ceiling conditions. Agnostic electromechanical design simply integrates with lighting control protocols such as 0-10V, DALI, and a variety of energy management systems.

0 - 10V



AcuityControls >

DISTECH  
CONTROLS

legrand > Wattstopper Pass & Seymour

LEVITON E.T.N. CRESTRON

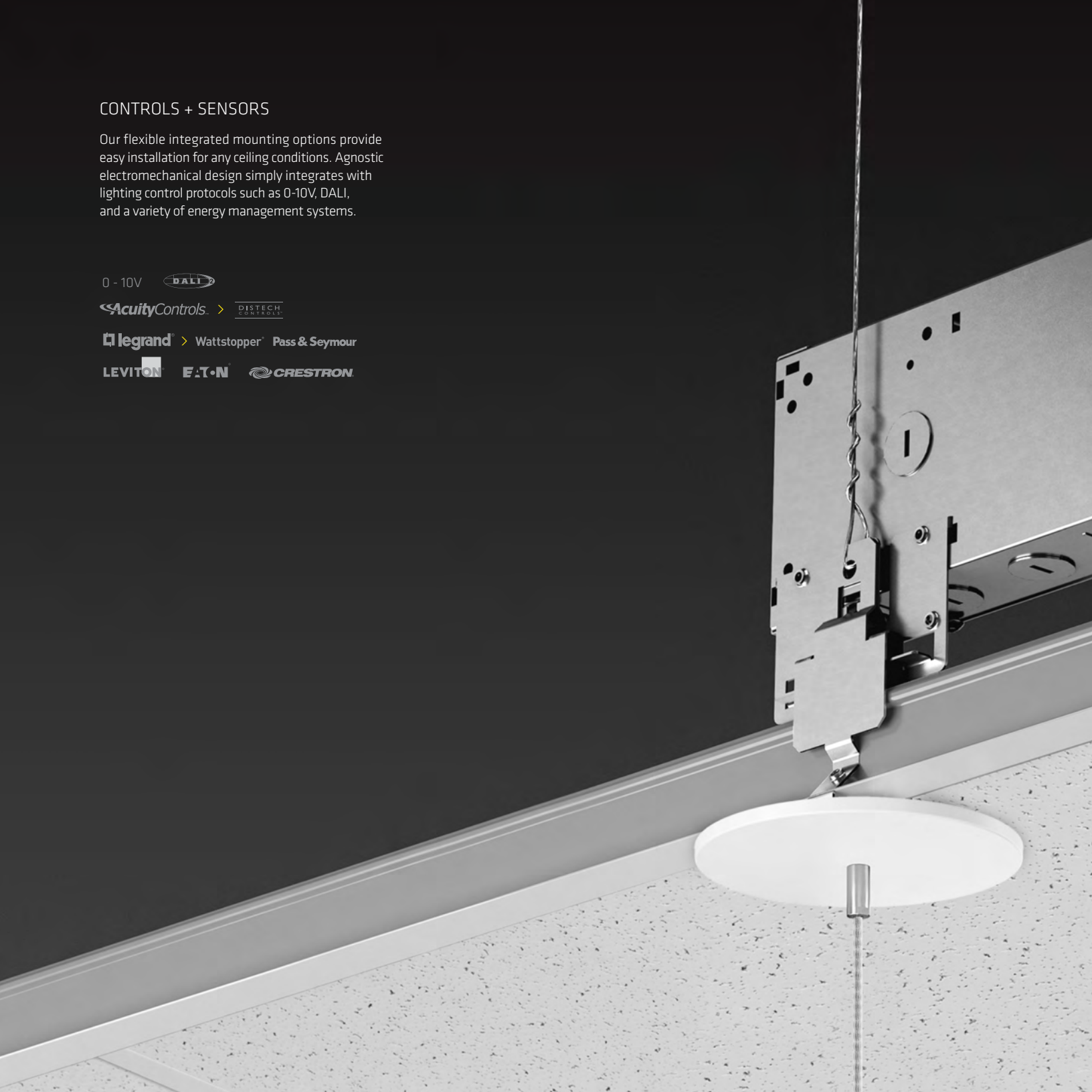





## enlighted

Enlighted wireless, networked smart sensor integrates occupancy sensing, daylight harvesting, energy usage, temperature and light level control.

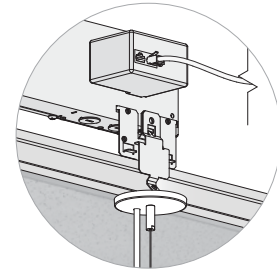

## nLIGHT

nLight wired, 2-way network supports luminaire light level control as well as occupancy and daylight sensors.

## eldoLED

EldoLED drivers support common wired protocols, 0-10V and DALI. They also provide access to finer dimming control, dynamic white and Bluetooth low-energy (BLE) wireless.

## LUTRON

Lutron EcoSystem network protocol enables on/off, dimming, occupancy sensing and daylight harvesting capabilities.

## INTEGRATED DRIVERS

Prewired and fully tested drivers are integrated with specialized mounting hardware, power feeds, suspension cables, and canopy components. Designed for multiple orientations and to accommodate a variety of ceiling conditions. Elements can be installed in advance or with fixtures, for new construction or retrofit applications.

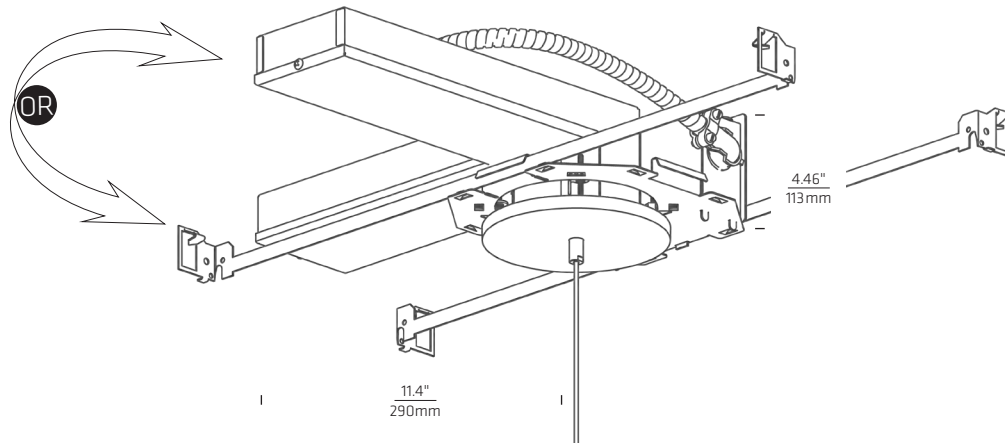

### (D) Drywall

Suitable for new construction or retrofit installation

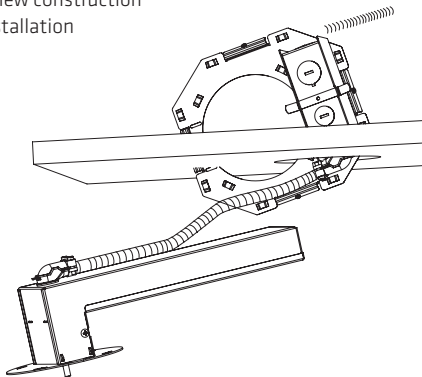

### Drywall canopy

0.39" / 10mm

5.51" / 140mm

### (G) Grid

Universal T-bar bracket attaches ON or OFF grid horizontally or vertically

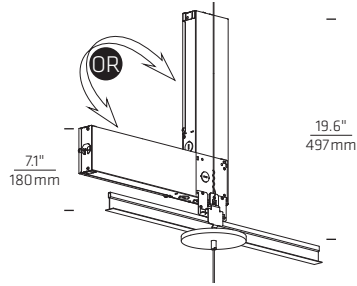

### Detached Method

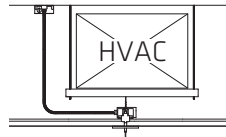

### Off Grid Installation

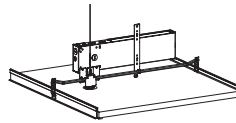

For accessible ceiling grid <1.75 (44 mm) tall

### T-bar canopy

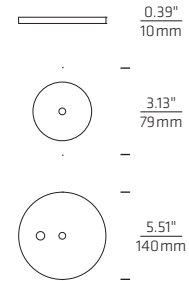

BP Canopy w/ test switch

NOTE: For BP enclosure dimensions see Remote spec sheet\*

### (S) Structure

Driver Canopy & Mount Power & Non-Power 120-277 V

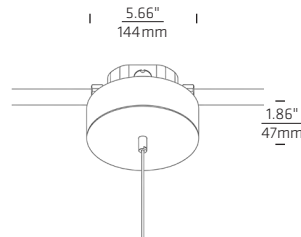
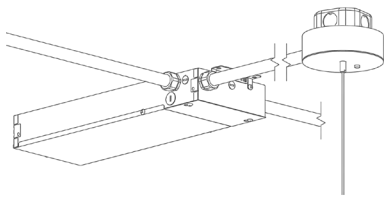

### (B) Battery Pack Driver Enclosure



Driver Canopy  
347 V

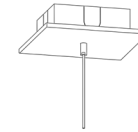

Non-Power Canopy  
347 V

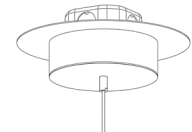

(P) Optional Oversized (9")  
J-box Canopy 120-277 V

### (R) Remote

Driver Enclosure

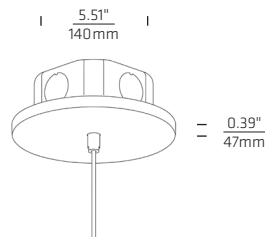
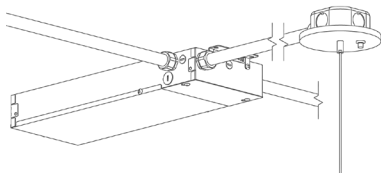

### J-Box



Mounting bracket

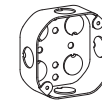

4" Octagon junction  
box (by others)

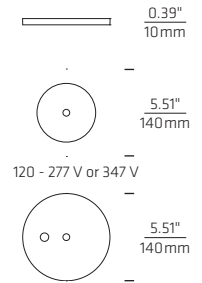

120 - 277 V or 347 V

Battery pack w/test button

## DESIGNED WITH YOU IN MIND

When you order Fluxwerx products, you don't just get high quality luminaires, you get instant online quoting and documentation tools, simple order processing, customer service support and contractor-ready shipments. Everything you need to ensure fast, accurate delivery for the tightest project schedule.



**SAME DAY QUOTATIONS.  
INSTANT DOCUMENTATION.**

**SERVICE RESPONSE  
WHEN YOU NEED IT**

**SEAMLESS  
+ SIMPLE**

**DETAILS  
THAT MATTER**



Our online quotation system is designed to build a complete project quote from millions of possible configurations in a matter of minutes, without having to call the factory. Plus, you can download all the drawings and details for your specific project immediately after building your quote—or making revisions to an existing quote. No waiting and no down time.

We understand that questions pop up fast, and receiving answers quickly is crucial to moving ahead with your project. We measure our response time in minutes, not hours or days. When you need answers, we're here to help. Contact us and a member of our Service Team will answer—no switchboards or operators.

Invisible design details require no electrical connections at fixture joints, creating virtually seamless continuous runs that are simple to install and speed construction. To minimize installation time and ensure precision alignment, all our fixtures arrive with endcaps and power drop cords factory installed, and drivers are pre-wired and tested for every circuit.

When you're on the job site, time is money. That's why all of our shipments come with spare parts and tools to save time. We also include consolidated and color coded wiring diagrams, installation instructions and project documentation, so that installers have the information they need at their fingertips. Look for the box with the yellow label marked CONTRACTOR CARE KIT.

FLUXWERX SERVICE TEAM

604.549.9379

[serviceteam@fluxwerx.com](mailto:serviceteam@fluxwerx.com)





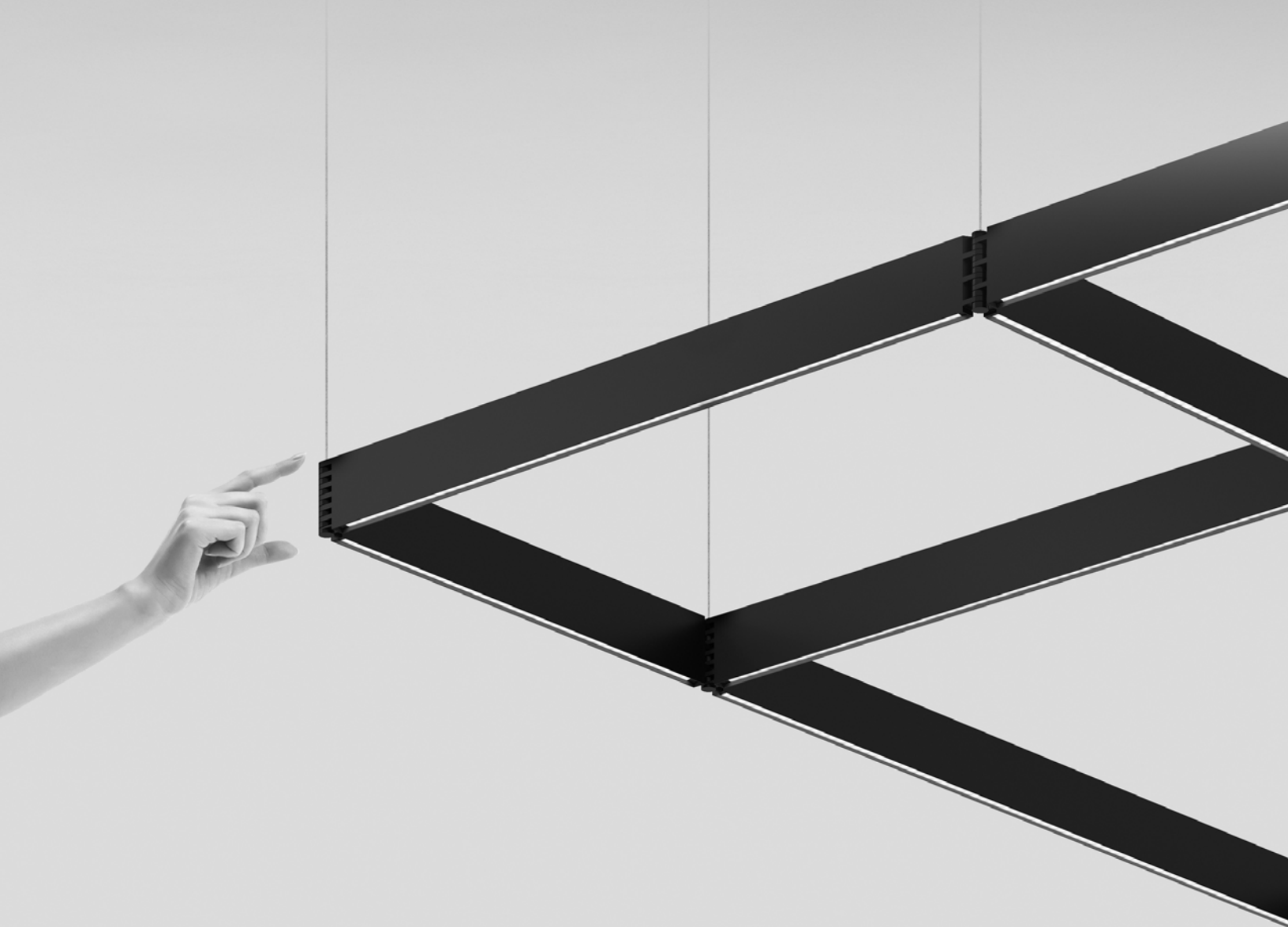

...light connects architecture + humanity

FLUXWERX. 







EXPLORE LINES

All Rights Reserved  
© 2022 Fluxwerx Illumination

All specifications and designs subject to change without notice

FLUXWERX.

Fluxwerx Illumination  
9255 - 194th Street  
Surrey, BC Canada V4N 4G1  
T 604.549.9379

[fluxwerx.com](http://fluxwerx.com)